

POLE SHAFT SPECIFICATIONS				
1.	SHAFTS ARE ONE SECTION DESIGN FABRICATED FROM 6063 T6 ALUMINUM EXTRUSION.			
2.	BASE CASTING IS 356 T6 ALUMINUM. THE SHAFT TELESCOPES INTO THE BASE CASTING AND IS CIRCUMFERENTIALLY WELDED TOP AND BOTTOM.			
3.	ANCHOR BOLTS ARE "L" FORMED RODS HAVING A MINIMUM YIELD STRENGTH OF 55,000 P.S.I. FABRICATED FROM ASTM F1554 GR. 55 AND FULLY GALVANIZED PER ASTM 153 SPECIFICATIONS AND FURNISHED COMPLETE WITH 2 HEX NUTS AND 2 FLAT WASHERS.			
4.	POLES SHALL HAVE A POLYESTER POWDER COAT FINISH IN A STANDARD COLOR.			
POLE DIMENSIONS				
POLE HGT. (FT.)	TOP DIA. (IN.)	BOTTOM DIA. (IN.)	GAGE	MTG. HGT. (FT.)
18'	5.00	5.00	.188	18'
BASE PLATE DIMENSIONS				
BOLT CIRCLE (IN.)	BASE PLATE DIM. (IN.)	BOLT HOLE (IN.)	PLATE THK. (IN.)	
7.50-9.00	10.75 SQ	.81	.75	
ANCHOR BOLT DIMENSIONS				
ANCHOR BOLT DIA. (IN.)		ANCHOR BOLT LENGTH (IN.)		
.75		20.00		
ALLOWABLE WIND LOADING (SQ. FT.)				
WIND*	80 MPH	90 MPH	100 MPH	120 MPH
EPA	9.8	7.3	5.3	3.3

\*WITH 1.3 GUST FACTOR

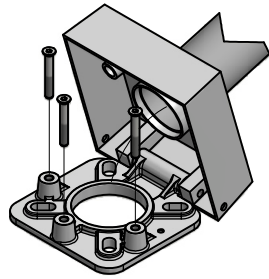

BASE ROTATION DETAIL VIEW

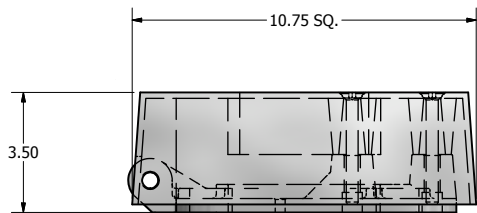
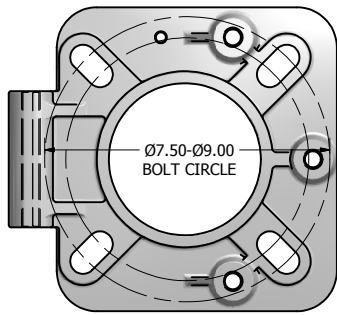

10.75 X 10.75 X 3.50 THK. BASE CASTING

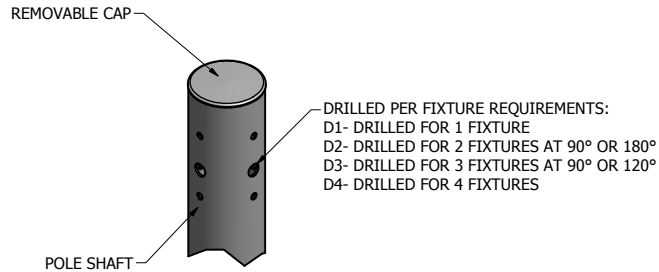

DRILLED MOUNT OPTIONS

DRILLED PER FIXTURE REQUIREMENTS:  
 D1- DRILLED FOR 1 FIXTURE  
 D2- DRILLED FOR 2 FIXTURES AT 90° OR 180°  
 D3- DRILLED FOR 3 FIXTURES AT 90° OR 120°  
 D4- DRILLED FOR 4 FIXTURES

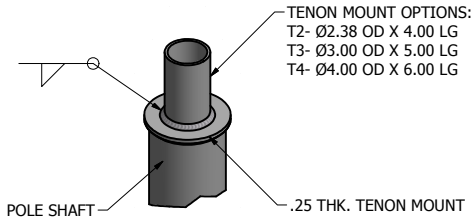

TENON MOUNT OPTIONS

TENON MOUNT OPTIONS:  
 T2- Ø2.38 OD X 4.00 LG  
 T3- Ø3.00 OD X 5.00 LG  
 T4- Ø4.00 OD X 6.00 LG

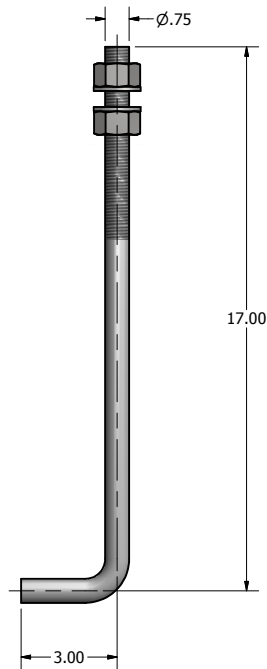

Ø.75 X 20.00 ANCHOR BOLT

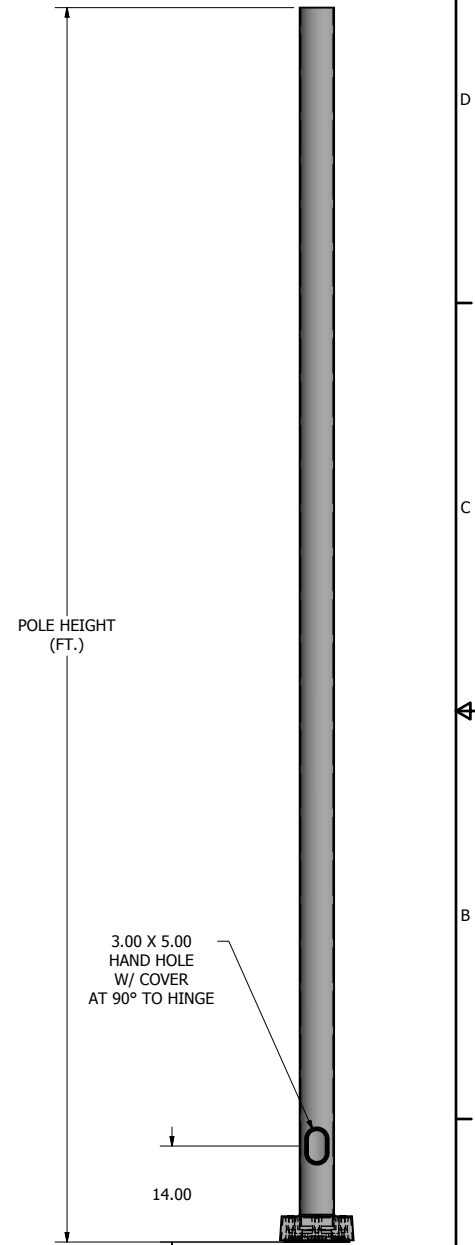

POLE DETAIL

**lyte poles**  
 a DWM company  
 P.O. Box 340  
 Eastpointe, MI 48021  
 P: (586) 771-4610 | F: (586) 771-5527  
 www.lytepoles.com

DRAWN: M. HARVALA	2/13/2015
CHECKED:	
REVISION:	DATE:
APPROVED:	
QUOTE:	
S.O.#	
REF:	SCALE: NONE

SOME GEOGRAPHICAL AREAS HAVE SPECIAL WIND CONDITIONS THAT CAN CREATE WIND INDUCED VIBRATIONS CAUSING A FATIGUE PROBLEM. NO METHOD HAS YET BEEN FOUND FOR PREDICTING DESTRUCTIVE LIGHTING POLE VIBRATION. THESE CONDITIONS ARE UNIQUE AND CANNOT BE GUARANTEED AGAINST, AND ARE THE RESPONSIBILITY OF A LOCAL SITE ENGINEER.	
TITLE:	
CATALOG:	
DWG NO: 605-5018-18	SIZE C
SHEET 1 OF 1	

